

Operating and Installation Instructions

Ventilation Hood



To prevent accidents and damage to the appliance, you **must** read these instructions before installing the appliance and using it for the first time.

Contents

IMPORTANT SAFETY INSTRUCTIONS	4
Caring for the environment	13
Description of functions	14
Con@ctivity 2.0 function.....	15
Guide to the appliance	16
Operation (Automatic mode)	18
Cooking with Con@ctivity 2.0 (Automatic mode).....	18
Temporarily exiting Automatic mode.....	20
Resuming Automatic mode.....	20
Operation (Manual mode)	21
Cooking without Con@ctivity 2.0 (Manual mode)	21
Remote control.....	21
Extending the deflector plate, switching the fan on.....	21
Switching on manually	21
Selecting the power level	22
Selecting the delayed shut down time	22
Turning off the fan	22
Switching the overhead lighting on/off.....	23
Power management	23
Operation (Automatic and Manual modes)	25
Filter saturation indicator.....	25
Adjusting the filter saturation timer for grease filters.....	25
Activating/changing the charcoal filter saturation timer	26
Checking the elapsed operating time	27
Energy-saving tips	28
Cleaning and care	29
Stainless steel housing.....	29
Grease filters	30
OdorFree Charcoal Filter	32
Resetting the filter saturation indicator for the charcoal filter	33
Disposing of the OdorFree charcoal filter.....	33
Remote control.....	34
Cleaning the remote control.....	34
Changing the battery.....	34
Service and warranty	35
Location of the data plate	35

MieleCare	35
Installation	36
Installation parts	36
Appliance dimensions	38
Distance between cooktop and ventilation hood (S).....	41
Installation recommendations	42
Before installation.....	42
Installation Instructions	44
Electrical connection	45
Air venting	46
Condensate trap.....	47
Reducing Collar	47
Activating Con@ctivity 2.0	48
Installation of the Con@ctivity 2.0 stick.....	48
Activating the Con@ctivity 2.0 function.....	48
Activating the ventilation hood.....	48
Activating the cooktop	49
Activation failed.....	49
Deactivating Con@ctivity 2.0.....	49
Signing the remote control on/off	50
Technical data	52

IMPORTANT SAFETY INSTRUCTIONS

READ AND SAVE THESE INSTRUCTIONS

This appliance complies with current safety requirements. Improper use of the appliance can lead to personal injury and material damage.

Read all instructions before installing or using the appliance for the first time. Only use the appliance for its intended purpose.

Keep these operating instructions in a safe place and pass them on to any future user.

Use

- ▶ **CAUTION:** For General Ventilating Use Only. Do Not Use To Exhaust Hazardous Or Explosive Materials And Vapors.
- ▶ This appliance is intended for residential use only. Use only as described in these operating instructions.
- ▶ This ventilation hood is not intended for outdoor use.
- ▶ It must only be used to extract and clean vapors produced during cooking. Any other use occurs at the owner's own risk.
- ▶ This appliance is suitable for installation above gas or electric cooking surfaces.
- ▶ Persons who lack physical, sensory or mental abilities, or experience with the appliance should not use it without supervision or instruction by a responsible person.

IMPORTANT SAFETY INSTRUCTIONS

Children

- ▶ As with any appliance, close supervision is necessary when used by children.
- ▶ Please supervise children in the vicinity of the hood and do not let them play with it.
- ▶ Danger of suffocation! Ensure that any plastic wrappings, bags, etc. are disposed of safely and kept out of the reach of children.
- ▶ Keep the battery for the remote control out of the reach of children.

Technical safety

- ▶ **WARNING: TO REDUCE THE RISK OF FIRE, ELECTRIC SHOCK, OR INJURY TO PERSONS, OBSERVE THE FOLLOWING:**
 - Use this appliance only in the manner intended by the manufacturer. If you have questions, contact Miele.
 - Before servicing or cleaning the appliance, switch power off at the service panel and lock the service disconnecting means to prevent power from being switched on accidentally. If the service disconnecting means cannot be locked, securely fasten a prominent warning device, such as a tag, to the service panel.
- ▶ Installation, repair and maintenance work should be performed by a Miele authorized service technician in accordance with national and local safety regulations and the provided installation instructions. Contact Miele's Technical Service Department for examination, repair or adjustment. Repairs and other work by unauthorized persons could be dangerous and may void the warranty.
- ▶ A damaged ventilation hood can be dangerous. Always check for visible signs of damage. Never use a damaged ventilation hood.

IMPORTANT SAFETY INSTRUCTIONS

- ▶ Be certain your appliance is properly installed and grounded by a qualified technician. To guarantee the electrical safety of this appliance, continuity must exist between the appliance and an effective grounding system. It is imperative that this basic safety requirement be met. If there is any doubt, have the electrical system of the house checked by a qualified electrician.
- ▶ Reliable and safe operation of this hood can only be guaranteed if it has been connected to the electrical supply.
- ▶ To avoid damaging the ventilation hood, make sure that the connection data (voltage and frequency) on the data plate correspond to the building's power supply before connecting the appliance. When in doubt, consult a qualified electrician.
- ▶ Do not use a power bar or extension cord to connect the ventilation hood to electricity. These are a fire hazard and do not guarantee the required level of appliance safety.
- ▶ To ensure safe operation, only use the ventilation hood after it has been properly installed.
- ▶ This ventilation hood may not be used in non-stationary locations (e.g. on a ship).
- ▶ Adequate ventilation must be provided when the hood is operated simultaneously with devices that burn gas or other fuels.
- ▶ Only open the housing as described in the enclosed "Installation diagram" and in the "Cleaning and care" section of this manual. Under no circumstances should any other parts of the housing be opened.
Tampering with electrical connections or components and mechanical parts is highly dangerous to the user and can cause operation faults.
- ▶ Defective components should be replaced by Miele original parts only. Only with these parts can the manufacturer guarantee the safety of the appliance.

IMPORTANT SAFETY INSTRUCTIONS

- ▶ If the power cord is damaged, it must only be replaced by a qualified service technician.
- ▶ During installation, maintenance, and repair work, the ventilation hood must be disconnected from the electrical supply. It is only completely isolated from the electricity supply if one of the following applies:
 - The circuit breakers on the electrical service panel are tripped.
 - The screw-type fuses on the electrical service panel have been removed.
 - The power cable (if present) has been unplugged from the socket (pull the plug not the cord).

Proper use

- ▶ **WARNING: TO REDUCE THE RISK OF A COOKTOP GREASE FIRE:**
 - a) Never leave surface units unattended at high settings. Boilovers cause smoking and greasy spillovers may ignite. Heat oils slowly on low or medium settings.
 - b) Always turn the hood on when cooking at a high heat.
 - c) Clean the ventilation hood frequently. Grease should not be allowed to accumulate on the fan or filter.
 - d) Use the proper pan size. Always use cookware appropriate for the size of the cooking area.
- ▶ Never use an open flame beneath the ventilation hood. To avoid the risk of fire, do not flambé or grill over an open flame. When turned on, the ventilation hood will draw any flames into the filter. Fat deposits may ignite.
- ▶ **WARNING: TO REDUCE THE RISK OF INJURY TO PERSONS IN THE EVENT OF A COOKTOP GREASE FIRE, OBSERVE THE FOLLOWING*:**

IMPORTANT SAFETY INSTRUCTIONS

- a) SMOTHER FLAMES with a close fitting lid, cookie sheet, or metal tray then turn off the burner. BE CAREFUL TO PREVENT BURNS. If the flames do not go out immediately, EVACUATE AND CALL THE FIRE DEPARTMENT.
- b) NEVER PICK UP A FLAMING PAN - You may be burned.
- c) DO NOT USE WATER, including wet dishcloths or towels - a violent steam explosion will result.
- d) Use a fire extinguisher ONLY if:
 - 1) You have a class ABC extinguisher, and you know how to operate it.
 - 2) The fire is small and contained in the area where it started.
 - 3) The fire department is being called.
 - 4) You can fight the fire with your back to an exit.

*Based on "Kitchen Firesafety Tips" published by NFPA.

▶ The ventilation hood may become damaged if exposed to excessive heat from a gas cooktop.

- When using the ventilation hood over a gas cooktop, ensure that any burners in use are always covered by cookware. Turn burners off when removing the cookware, even if doing so for just a short time.
- Select cookware that is suitable for the size of the burner.
- Adjust the flame so that it never extends up the sides of the cookware.
- Avoid overheating the cookware (e.g., when cooking with a wok).

▶ Always turn the ventilation hood on whenever a burner is in use to prevent damage from condensation.

▶ Overheated oils and fats can ignite and set the ventilation hood on fire.

When cooking with oils or fats, do not leave pots, pans or fryers unattended. Never leave an electric grill unattended when grilling.

IMPORTANT SAFETY INSTRUCTIONS

▶ Fat and debris deposits impair the proper functioning of the ventilation hood.

To ensure that cooking vapors are properly cleaned, never use the ventilation hood without the grease filters in place.

▶ There is a risk of fire if cleaning is not completed according to the instructions in this manual.

▶ Please note that the heat rising from the stovetop during cooking can cause the ventilation hood to become very hot.

Do not touch the housing or the grease filters until the ventilation hood has cooled down.

IMPORTANT SAFETY INSTRUCTIONS

Proper installation

- ▶ **WARNING: TO REDUCE THE RISK OF FIRE, ELECTRIC SHOCK, OR INJURY TO PERSONS, OBSERVE THE FOLLOWING:**
 - a) Installation work and electrical wiring must be done by qualified person(s) in accordance with all applicable codes and standards, including fire-rated construction.
 - b) Sufficient air is needed for combustion and exhausting of gases through the flue (chimney of fuel burning equipment to prevent back drafting. Follow the heating equipment manufacturer's guideline and safety standards such as those published by the National Fire Protection Association (NFPA) and the American Society for Heating, Refrigeration and Air Conditioning Engineers (ASHRAE), and the local code authorities.
 - c) When cutting or drilling into the wall or ceiling, do not damage electrical wiring and other hidden utilities.
 - d) Ducted hoods must always be vented to the outdoors.
 - e) Do not use this hood with any solid-state speed control device.
- ▶ To determine whether a ventilation hood may be operated above your cooking appliance, please refer to the information provided by the appliance's manufacturer.
- ▶ Safety regulations prohibit the installation of a ventilation hood above solid fuel stoves.
- ▶ Insufficient distance between the cooking appliance and the ventilation hood can result in damage to the hood.
The minimum safety distances between the appliance and the bottom of the ventilation hood specified in the "Installation" section must be maintained, unless the appliance's manufacturer has indicated that a greater distance is required.
If more than one cooking appliance is used beneath the ventilation hood, and if different minimum safety distances apply for these appliances, you should use the greater distance.

IMPORTANT SAFETY INSTRUCTIONS

- ▶ Be sure to observe the information contained in the "Installation" section when mounting the ventilation hood.
- ▶ Metal parts can have sharp edges which may cause injury. Wear gloves to protect your hands from being cut.
- ▶ When installing the exhaust duct, only use pipes or tubes made of non-flammable material. These can be obtained from your Miele dealer or from Miele Technical Service.
- ▶ Exhaust air should not be vented into a chimney or vent flue which is otherwise in use and should not be channeled into ducting which ventilates rooms with fuel-burning installations.
- ▶ If exhaust air is to be extracted into a chimney or vent flue no longer used for other purposes, be sure to comply with all applicable regulations.
- ▶ **WARNING: TO REDUCE THE RISK OF FIRE USE ONLY METAL DUCTWORK.**

Cleaning and care

- ▶ Never use a steam cleaner to clean the ventilation hood. The steam can reach the electrical components and cause a short circuit.
- ▶ Important information on handling the remote control battery:
 - Do not short circuit or recharge the battery, or throw it into a fire. Danger of explosion!
 - Do not throw old batteries away with your general household waste. Please dispose of them in a designated battery collection and recycling system.

Accessories

- ▶ Use only genuine original Miele parts. If parts or accessories from other manufacturers are used, the warranty will become void.

IMPORTANT SAFETY INSTRUCTIONS

FCC Declaration of Conformity

▶ These devices comply with FCC Rules Part 15. This equipment has been tested and found to be in compliance with the limits for a Class B digital device, pursuant to Part 15 of the FCC Rules of Operation and is subject to the following conditions:
These devices may not cause harmful interference.
These devices must accept any interference received, including interference that may cause undesired operation.

FCC Radiation Exposure Statement

▶ This equipment complies with FCC radiation exposure limits set forth for an uncontrolled environment. This equipment should be installed and operated with minimum distance 8" (20 cm) between the radiator and your body.

Industry Canada Statement

▶ This digital apparatus does not exceed the Class B limits for Radio Noise Emissions from digital apparatus set out in the Radio Interference Regulations of the Canadian Department of Communications.

Complies with Canadian ICES-003 Class B specifications.

Disposal of the packing material

The cardboard box and packing materials protect the appliance during shipping. They have been designed to be biodegradable and recyclable.

Ensure that any plastic wrappings, bags, etc. are disposed of safely and kept out of the reach of children.
Danger of suffocation!

Disposal of your old appliance

Do not dispose of this appliance with your household waste.

Old appliances may contain materials that can be recycled. Please contact your local recycling authority about the possibility of recycling these materials.

Before discarding an old appliance ensure that it presents no danger to children while being stored for disposal. Unplug it from the outlet, cut off its power cord and remove any doors to prevent hazards.

Description of functions

The following functions are available on your ventilation hood, depending on the model:

Vented mode

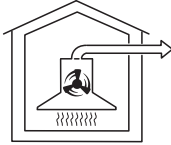

da100494a

The air is drawn in and cleaned by the grease filters and directed outside.

Non-return flap

A non-return flap in the ducting prevents the exchange of inside and outside air from occurring when the ventilation hood is not in use.

The flap is closed when the ventilation hood is turned off.

When the ventilation hood is turned on, the non-return flap opens so that the exhaust air can be transported outside without any obstruction.

A non-return flap has been provided with the hood in case your ducting does not have one. It is inserted into the outlet duct collar of the fan.

Recirculation mode

Recirculation mode hoods require a recirculation kit and OdorFree Charcoal Filters (available as optional accessories), see "Technical Data" for more information.



da100494b

The air is drawn in and cleaned first by the grease filters and then by the charcoal filters. The clean air is then recirculated back into the kitchen.

Con@ctivity 2.0 function

Automatic control

This hood features a communication function which enables the automatic control of the hood based on the operational status of a Miele cooktop.

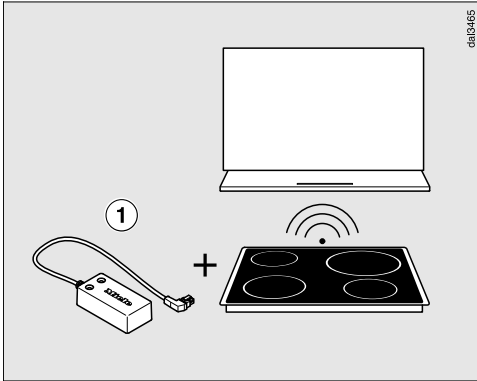

The cooktop transmits information about its operational status to the hood using a radio signal.

- When the cooktop is switched on, the cooktop lighting comes on automatically, the fan switches on, and the canopy extends.
- During cooking, the hood automatically selects the fan level based on the number of burners in operation and their power levels.
- After cooking, the fan and the cooktop lighting switch off automatically and the canopy retracts.

Detailed information about this function can be found under "Operation."

To enable the communication function, the cooktop must be equipped with the corresponding Con@ctivity 2.0 stick ①.

Please refer to the installation instructions for the Con@ctivity 2.0 stick to determine whether connection to your cooktop is possible.

There must be radio contact between the cooktop and the hood for you to be able to use the Con@ctivity 2.0 function (see "Activating Con@ctivity 2.0").

Guide to the appliance

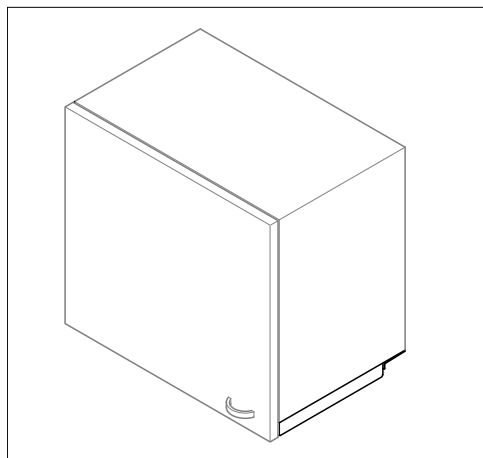

0413464

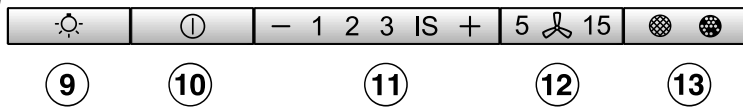
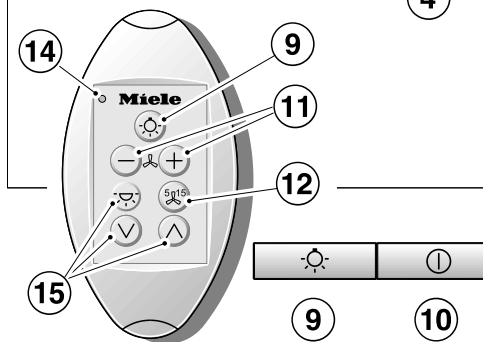
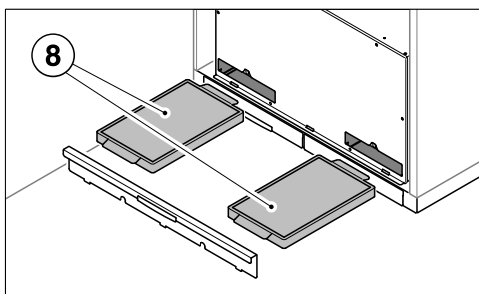
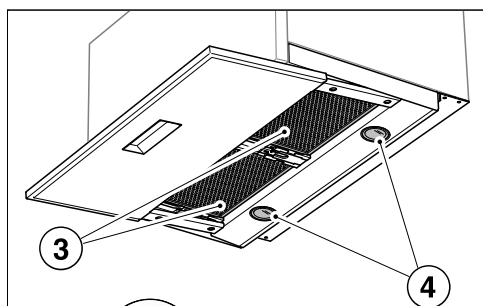
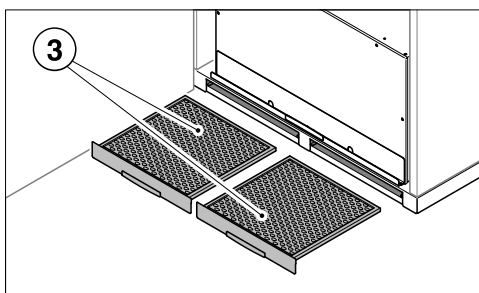
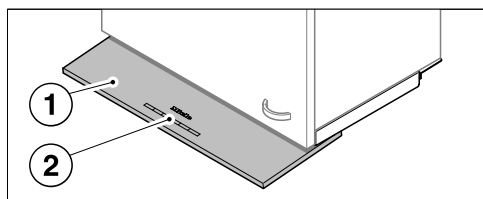
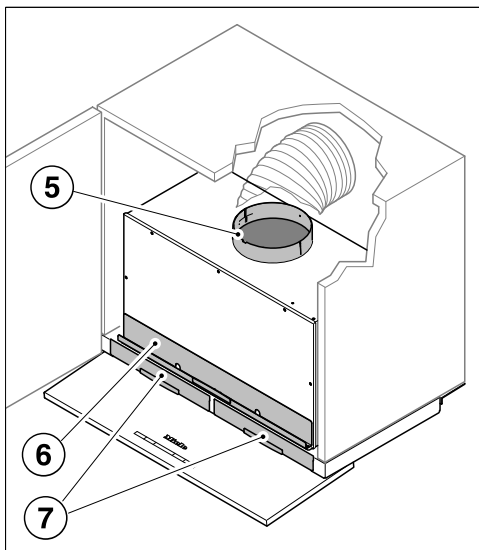

- ① Retractable canopy
- ② Control panel
- ③ Grease filters
- ④ Overhead cooktop LED lighting
- ⑤ Vent connection
The exhaust collar can also be fitted at the back.
- ⑥ Slots for the charcoal filters
- ⑦ Slots for the grease filters
- ⑧ Charcoal filter
Optional accessory for recirculation mode
- ⑨ Overhead lighting button
- ⑩ On/Off control for the retractable canopy and the fan
- ⑪ Buttons for setting the fan power
The controls on the remote control are also used to extend and retract the canopy and to switch the fan on and off.
- ⑫ Delayed shut down button
- ⑬ Filter saturation indicator
- ⑭ Indicator light
- ⑮ Controls for programming

Operation (Automatic mode)

When Con@ctivity 2.0 is active, the hood always operates in Automatic mode (see "Activating Con@ctivity 2.0").

See "Cooking without Con@ctivity 2.0" for information on manually operating the hood.

Cooking with Con@ctivity 2.0 (Automatic mode)

- Turn on a burner to the desired power setting.

The hood lighting will come on.

After a few seconds the fan will come on at power level **1**. The canopy extends.

The hood selects the fan level automatically during cooking.

This level is determined by the total output of the cooktop, i.e. the number of burners in operation and the power settings selected.

- If you select a higher power setting on the cooktop or switch on multiple burners, the hood will switch to a higher fan level.
- If you select a lower power setting on the cooktop or turn off a burner, the hood will accordingly switch to a lower fan level.

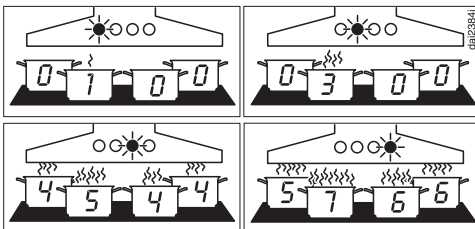

Examples for fan levels **1** to **4**

Reaction time

Changing the power setting on the cooktop does not lead to an immediate increase or decrease in cooking vapors. For this reason, the hood reacts with a slight delay.

Delays can also result from the fact that the cooktop transmits the information to the hood in intervals.

The reaction time can vary from a few seconds to a couple of minutes.

Cooking process

- If, for example, you switch on a burner at the highest power setting to heat cookware in preparation for searing and then reduce the power level after approx. 60 to 90 seconds, a cooking process is recognized.

The hood turns on automatically and, after the cooktop power level has been reduced, switches back to fan level 3, where it remains for approx. 5 minutes.

After this, the fan level is once again determined by the Con@ctivity function.

- You can also manually select a different fan level before then.

Deactivation

- Turn off all burners.

Over the next few minutes, the ventilation hood fan setting will decrease one level at a time until the hood eventually turns off.

This helps to neutralize any lingering vapors and odors in the air.

- From the intensive setting IS, the fan immediately switches to level 3.
- If the fan is operating at level 3, it will switch to level 2 after approx. 1 minute.
- From level 2, the fan switches to level 1 after 2 minutes.
- After 2 minutes at level 1, the fan switches itself off. The canopy retracts.
- After another 30 seconds, the lighting turns off.

The cooking process is now finished.

Operation (Automatic mode)

Temporarily exiting Automatic mode

To temporarily exit the Automatic mode when cooking:

- Manually select a different fan level, or
- Manually turn the hood off, or
- Activate the ventilation hood delayed shut down function . The fan will switch off after the selected time, the canopy will retract and the lighting remains switched on.

The ventilation hood functions can now be operated manually (see "Cooking without Con@ctivity 2.0").

Resuming Automatic mode

The ventilation hood resumes Automatic mode:

- If the ventilation hood has not been used for a period of approx. 5 minutes after the manual selection of a fan level, or
- If the manually selected fan level once again matches the automatic setting, or
- If the ventilation hood fan and the cooktop have been turned off for at least 30 seconds.
Automatic mode will resume the next time the cooktop is turned on.
- If you wish to manually operate the ventilation hood for a complete cooking process, turn on the ventilation hood fan **before** turning on the cooktop.
If the ventilation hood and the cooktop have been turned off for at least 30 seconds after you have finished cooking, Automatic mode will resume the next time the cooktop is turned on.

Cooking without Con@ctivity 2.0 (Manual mode)

The hood can be operated manually if:

- The Con@ctivity 2.0 function is not activated.
- You have temporarily deactivated the Con@ctivity 2.0 function (see "Temporarily exiting Automatic mode").

Remote control

The main functions can be selected via the ventilation hood or by remote control. The LED light on the remote control unit will light up briefly when a function is selected by remote control.

The maximum operating range of the remote control is approx. 32' 9" (10 m). However, this may be less depending on the physical conditions present in the room (e.g. furniture, walls).

The rear of the remote control unit is magnetic which allows it to be attached to various metal surfaces.

Extending the deflector plate, switching the fan on

- Press the "+" button on the remote control.

The deflector plate will come out. The fan will switch on at level **1**. The ① symbol and **1** will light up in the power level display.

Switching on manually

The canopy can also be operated without the remote control, e.g. if the remote control has been misplaced or the battery is flat.

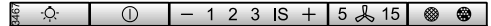
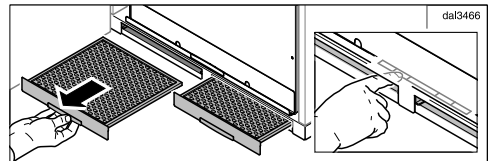

- Remove the grease filters.

The controls can now be accessed through the grease filter slots.

- Press the On/Off button ①.

The canopy comes out and the motor switches on at power setting **1**. You can change the power setting if required.

- Reinsert the grease filter.

Operation (Manual mode)

Selecting the power level

Power levels **1** to **3** can be used for light to heavy cooking vapors and odors.

For strong vapors and odors that are temporarily produced when cooking, e.g. during searing, select the **IS** level as an intensive setting.

- Press the "-" button for a lower power level or the "+" button to select a higher level.



Reducing power of the intensive setting

If power management is activated (default setting), the fan automatically switches back to level **3** after 5 minutes.

Selecting the delayed shut down time

It is advisable to run the fan for a few minutes after cooking has finished to neutralize any lingering vapors and odors in the air.

With the delayed shut down function the fan switches itself off automatically and the deflector plate retracts after a pre-selected time.

- After you have finished cooking, press the delayed shut down button **5**  **15**
 - Once: the fan will switch itself off after 5 minutes and the deflector plate will go back in (**5** lights up).
 - Twice: the fan will switch itself off after 15 minutes and the canopy will go back in (**15** lights up).
 - If you press the delayed shut down button **5**  **15** again, the fan remains turned on (**5**  **15** goes out).

Turning off the fan

- Press the On/Off control  on the ventilation hood or the "-" control on the remote control repeatedly until the fan switches off.

The fan switches off and the canopy retracts.

If the ventilation hood is switched on again while the canopy is retracting, the canopy will come back out again and then may retract again slightly.

- If this happens, you must switch the ventilation hood off and wait until the canopy has completely retracted.

The next time you switch on the ventilation hood, the canopy will extend again correctly.

Switching the overhead lighting on/off

The cooktop lighting can be switched on and off regardless of whether the canopy is extended or retracted.

- Press the lighting button  briefly to turn it on or off.

Power management

The ventilation hood features a power management system for saving energy. It is used for switching off the lighting, reducing the fan power level and retracting the canopy automatically when the ventilation hood is no longer being used.

- If the intensive setting is selected, the fan automatically switches to level 3 after 5 minutes.
- When the ventilation hood has been switched on but not used for 2 hours, the power will be reduced by one level at a time in 30-minute stages until the fan finally switches off. The canopy will retract.
- If the overhead lighting is on, it automatically turns off after 12 hours.

Operation (Manual mode)

Turning power management On/Off

You can deactivate the power management.

This can result in increased electricity consumption.

- Switch off the ventilation hood. The canopy must be retracted.

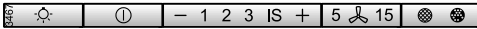
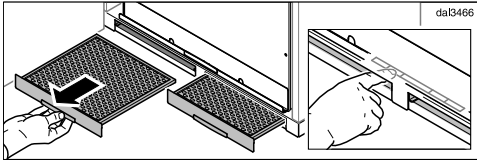



- Remove the grease filters.

The controls are accessible via the slots for the grease filters.

- Press and hold the delayed shut down button **5**  **15** for approx. 10 seconds until **1** appears in the fan level display.

- Then, press the following buttons in order:

- The lighting button ,
- Followed by the "-" button and then
- The lighting button  again.

If power management is turned on, the **1** and **IS** indicators will be continuously lit.

If it is turned off, **1** and **IS** will flash.

- Press the "-" button to turn power management off.

The **1** and **IS** indicators will flash.

- To turn it on, press the "+" button.

The **1** and **IS** indicators are constantly lit.

- Confirm the setting by pressing the delayed shut down button **5**  **15**.



All the indicator lights will go out.

If the new setting is not confirmed within 4 minutes, the hood reverts to the previous setting.

Operation (Automatic and Manual modes)

Filter saturation indicator

The number of hours the hood has been in operation is stored in appliance memory.

The filter saturation indicators show when the filters need to be cleaned or changed by lighting up the grease filter symbol  or OdorFree Charcoal Filter symbol . Additional information on cleaning and changing the filters and resetting the filter saturation counters can be found under "Cleaning and care."

Adjusting the filter saturation timer for grease filters

You can set the filter saturation indicator to suit your cooking habits.

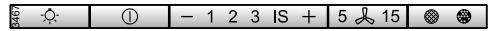
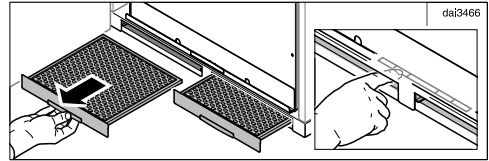

The factory default setting is a cleaning interval of 30 hours.

- Select a shorter time (20 hours) if you often fry foods.
 - We also recommend a shorter cleaning interval if you only cook occasionally. This will prevent grease buildup from hardening and making cleaning more difficult.
 - Select a longer cleaning interval of 40 or 50 hours if you use very little fat when cooking.
- Switch off the ventilation hood. The canopy must be retracted.



- Remove the grease filters.



The controls are accessible via the slots for the grease filters.

- Press the delayed shut down button **5 15** and the filter saturation button   at the same time.

The grease filter symbol  on the filter saturation button and one of the fan power level indicators will flash.

The indicators **1** to **IS** show the current time setting:

Indicator 1	20 hours
Indicator 2	30 hours
Indicator 3	40 hours
Indicator IS	50 hours

- Press the "-" symbol for a shorter operating time, or the "+" symbol to select a longer operating time.
- Confirm the selection by pressing the filter saturation indicator  .

All the indicator lights will go out.

If the new setting is not confirmed within 4 minutes, the hood reverts to the previous setting.

Operation (Automatic and Manual modes)

Activating/changing the charcoal filter saturation timer

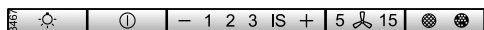
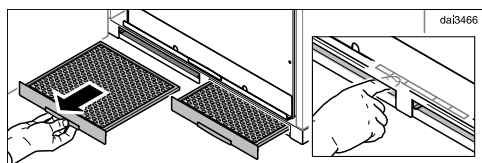

The filter saturation timer for the charcoal filter requires one-time activation and must be set to match your cooking habits.

- Switch off the ventilation hood. The canopy must be retracted.



- Remove the grease filters.

The controls are accessible via the slots for the grease filters.

- Press the "+" symbol and the filter saturation indicator   at the same time.

The charcoal filter symbol  and one of the fan power level indicators will flash.

The indicators **1** to **IS** show the current time setting:



Indicator **1** 120 hours

Indicator **2** 180 hours

Indicator **3** 240 hours

Indicator **IS** deactivated

- Press the "-" symbol for a shorter operating time, or the "+" symbol to select a longer operating time.

- Confirm the selection by pressing the filter saturation indicator  .





All the indicator lights go out.

If the new setting is not confirmed within 4 minutes, the hood reverts to the previous setting.

Operation (Automatic and Manual modes)

Checking the elapsed operating time

Before the set operating time interval has been reached, you can check what percentage of the time has elapsed.

- Press the On/Off button  to switch the fan on.
- Press and hold the filter saturation indicator  :
 - Once, to check the grease filter operating time. The grease filter symbol  lights up.
 - Twice, to check the charcoal filter saturation. The OdorFree Charcoal Filter symbol  lights up.

One or more of the fan power level indicators will flash simultaneously.

The number of flashing indicators shows the elapsed operating time as a percentage.

Indicator 1	25%
Indicators 1 and 2	50%
Indicators 1 to 3	75%
Indicators 1 to IS	100%

The elapsed operating time remains stored in the memory when the ventilation hood is turned off or if power to the appliance is lost.

Energy-saving tips

This hood operates in a very efficient and energy-saving manner. The following will help you to save even more energy when using it:

- Ensure that there is sufficient ventilation in the kitchen when cooking. If there is insufficient air flow during vented mode, the hood cannot operate efficiently, causing increased operating noise levels.
- Always cook with the lowest possible setting. This produces fewer cooking vapors so that you can use a lower hood power level and therefore benefit from reduced energy consumption.
- Use the Con@ctivity function. The ventilation hood will switch on and off automatically at the optimum power level for the cooking you are doing, which ensures low energy consumption.
- If you are operating the ventilation hood manually, please note the following:
 - Check the power level selected on the hood. A lower power level is generally sufficient for the majority of cooking. Only use the intensive setting when necessary.
 - When a large volume of cooking vapors are being produced, switch to a high power level in good time. This is more efficient than operating the hood for longer to try to capture cooking vapors that have already been distributed throughout the kitchen.
- Make sure that you switch the ventilation hood off after use. If cooking vapors and odors still need to be removed from the kitchen air after cooking, use the coast-down function. The fan will switch off automatically after the selected coast-down time.
- Clean or change the filters at regular intervals. Heavily soiled filters reduce performance, increase the risk of fire and are unhygienic.

WARNING: TO REDUCE THE RISK OF FIRE, ELECTRIC SHOCK, OR INJURY TO PERSONS, OBSERVE THE FOLLOWING:

- Before cleaning or servicing the hood, disconnect it from the power supply, see "IMPORTANT SAFETY INSTRUCTIONS".

Stainless steel housing

General information

The surfaces and control buttons are susceptible to scratching and chipping.

Observe the following cleaning instructions.

- Clean all surfaces and control buttons using warm water and liquid dish soap. Apply with a sponge cloth.

Make sure that no water gets into the interior of the hood.

Only use a damp cloth to clean the hood, especially in the control panel area.

- After cleaning, dry the surfaces with a soft cloth.

Avoid the following:

- Cleaners containing soda, acid or chloride, or cleaners containing solvents
- Abrasive sponges, e.g. pot scourers or sponges which have been previously used with abrasive cleaning agents.

Special instructions for stainless steel surfaces

(does not apply to control buttons)

- Stainless steel surfaces can also be cleaned using a non-abrasive stainless steel cleaner, available from Miele.
- To prevent the surfaces from quickly becoming dirty again, we recommend treating them with a stainless steel care conditioner. Apply sparingly over the entire area using a soft cloth.

Important for the controls

Do not leave dirt and debris on the buttons for any length of time.

Otherwise they may become discolored or damaged.

Remove any dirt or debris immediately.

- Observe the general cleaning instructions contained in this chapter.

Do not use a stainless steel cleaner to clean the control buttons.

Cleaning and care

Grease filters

The reusable metal grease filters in the appliance remove the solid particles contained in kitchen vapors (fat, dust, etc.), thereby preventing the ventilation hood from becoming dirty.

 A dirty filter is a fire hazard!

Cleaning intervals

Over longer periods of time, fat buildup on the grease filter hardens and makes cleaning more difficult. Therefore, we recommend cleaning the grease filters once every 3-4 weeks.

By illuminating the grease filter symbol, the filter saturation counter  reminds you to regularly clean the grease filters.

- You can adjust the interval of the filter saturation counter to match your cooking habits (see "Operation").

Removing the grease filters

During removal, the filter may drop to the ground.

This can result in damage to the filter and the cooktop.

During cleaning, be sure to hold the filter securely.

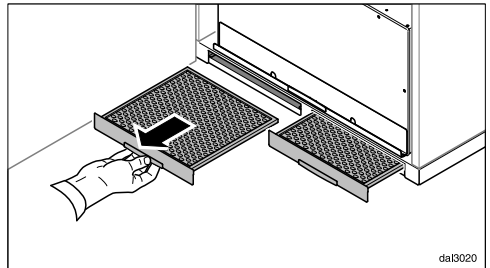

- Remove the grease filters from the slots on the front of the housing.

Cleaning the grease filters by hand

- Clean the filters with a soft nylon brush in a mild solution of hot water and dish soap. Do not use undiluted dish soap.

Unsuitable cleaning agents

Unsuitable cleaners can cause damage to the filter surfaces if used regularly.

Do not use any of the following:

- Lime removers
- Abrasive powders or abrasive liquids
- Aggressive all-purpose cleaners and degreaser sprays
- Oven sprays

Cleaning the grease filters in the dishwasher

- Place the filters as upright as possible in the lower basket. Ensure that the spray arm is not obstructed.
- Use a common dishwashing detergent.
- Select a program with a wash temperature between 120°F (50°C) and 150°F (65°C). In a Miele dishwasher use the "Normal" program.

Depending on the detergent used, cleaning the filters in a dishwasher may cause the inside filter surfaces to become discolored. However, this will not affect the functioning of the filters in any way.



After cleaning

- After cleaning, leave the filters on an absorbent surface to dry.
- When removing the filters for cleaning, also clean off any accessible oil or fat buildup from the housing. Doing so will prevent a fire hazard.
- Push the grease filters back in.

Cleaning and care



Resetting the filter saturation counter for the grease filters

Once cleaning is complete, the filter saturation counter must be reset.

- While the fan is turned on, press the filter saturation indicator   for approx. 3 seconds until **1** is the only indicator flashing.

The grease filter symbol  goes out.

When cleaning the grease filters before the full operating time has elapsed:

- Press the filter saturation indicator   for approx. 6 seconds until **1** is the only indicator flashing.

OdorFree Charcoal Filter

With recirculation mode, two charcoal filters must be fitted in addition to the grease filters. These are designed to absorb cooking odors.

Charcoal filters are available from your Miele dealer or from Miele. See "Technical data" for the type and reference number.

Installing/replacing the charcoal filter

The slots for the charcoal filters are located above the grease filters.

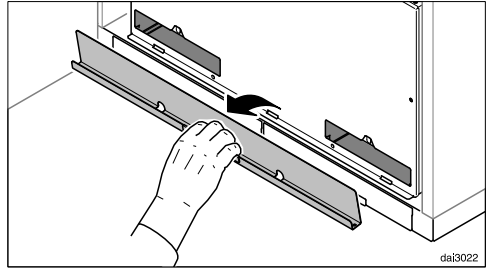

- Remove the cover. It is held in place by magnets.
- Remove the charcoal filter from its packaging.

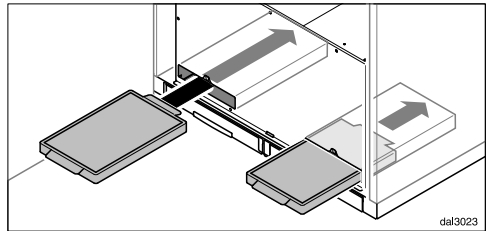

- Insert the charcoal filters in the slots.
- Refit the cover.
- When installing the filter for the first time, activate the filter saturation counter (see "Operation").

When to change the OdorFree Charcoal Filter



- Always replace the OdorFree Charcoal Filters whenever they no longer absorb kitchen odors effectively.
The charcoal filters should be replaced at least once every 6 months.

The charcoal filter saturation indicator  will light up to remind you to change the charcoal filter regularly.



- The charcoal filter saturation counter requires one-time activation before use (see the "Operation" chapter).

Resetting the filter saturation indicator for the charcoal filter

If the filter saturation counter is activated, it must be reset each time the filter is changed.

- To do this, press the filter saturation indicator   twice with the fan turned on and hold it for approx. 3 seconds until **1** is the only indicator flashing. The charcoal filter symbol  will go out.

If you replace the charcoal filters **before** the full time interval elapses:

- Press the filter saturation indicator   twice and hold it for approx. 6 seconds until **1** is the only indicator flashing.

Disposing of the OdorFree charcoal filter

- Used charcoal filters can be disposed of with normal household waste.

Cleaning and care

Remote control

Cleaning the remote control

- Only clean the surface with a damp cloth. Do not use too much water to avoid moisture penetrating the casing.

Changing the battery

Use only the type of battery listed.
Do not use rechargeable batteries.

The remote control requires one 3V CR 2032 battery.

The battery must be changed if ventilation hood functions can no longer be selected using the remote control or if the LED light on the remote control does not light up, or only lights up dimly when a control is pressed.

Ventilation hood functions can still be selected using the ventilation hood controls.

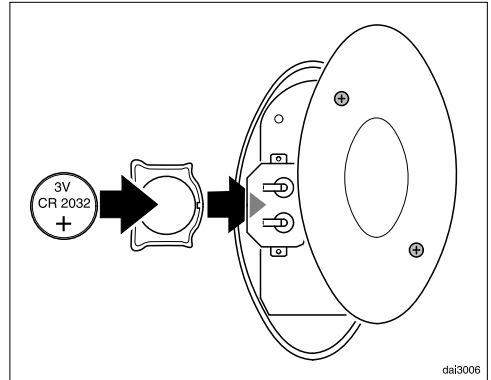

- Use a screwdriver to loosen the two screws on the back and remove the cover.
- Remove the old battery and replace with a new one, making sure the polarity is correct.
- Refit the cover.
- Dispose of the old battery responsibly.

For faults that you cannot resolve on your own, please contact your Miele dealer or Miele Technical Service.

The telephone number for Miele is listed at the back of these instructions.

When contacting Miele, please state the model and serial number of your ventilation hood.

These can be found on the data plate.

Location of the data plate

The data plate is visible once you have removed the grease filters.

Warranty

For further information, please refer to your warranty booklet.

MieleCare

This service is available in USA only.
--

MieleCare, our Extended Service Contract program, gives you the assurance of knowing that your appliance investment is covered by 5 years of worry free ownership.

MieleCare is the only Extended Service Contract in the industry that guarantees repairs by a Miele Authorized Service Provider using genuine Miele parts. Only genuine Miele parts installed by factory trained professionals can guarantee the safety, reliability, and longevity of your Miele appliance.

Please note that unless expressly approved in writing by Miele's Service department, Extended Service Contracts offered by other providers for Miele products will not be recognized by Miele. Our goal is to prevent unauthorized (and untrained) service personnel from working on your Miele products, possibly doing further damage to them, you and/or your home.

To learn more about **MieleCare** Extended Service Contracts, please contact your appliance dealer or visit us online at:

www.mieleusa.com

Installation

Installation parts

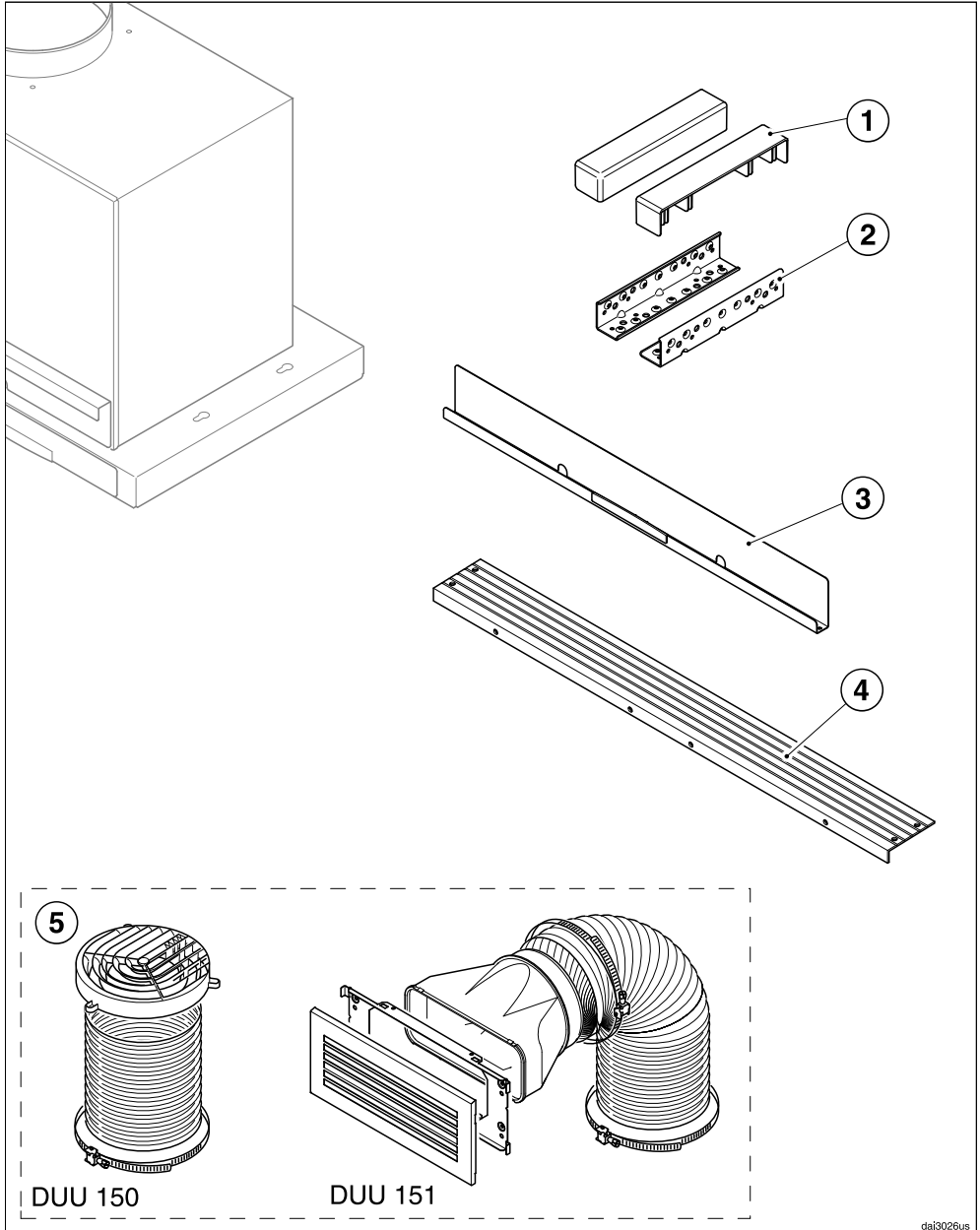

- ① **2 covers** for the brackets.
- ② **2 brackets** to support the appliance in the wall unit.
- ③ **1 cover** for the charcoal filter slots.
- ④ **1 spacer strip** to conceal the gap between the rear of the appliance and the wall.
- ⑤ **Conversion kit for recirculation mode** (the conversion kit is not supplied. It must be ordered separately as an optional accessory - see "Technical data"). The kit contains an exhaust grille and flexible aluminum hose with hose clips.



12 screws 4 x 15 mm (9/16") for securing the ventilation hood to the wall unit.



4 screws M4 x 16 mm (5/8") for securing the ventilation hood to the brackets and for securing the spacer strip.



4 screws M4 x 8 mm (5/16") for securing the spacer strip.



4 screws 4 x 25 mm (1") for securing a 900 mm (35 7/16") wide ventilation hood.



4 adhesive covers to conceal the fixing holes which are not required.

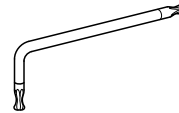

1 x T 20 angled key

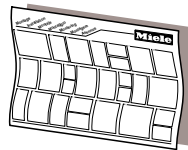

Installation instructions

07602740

08095672

07203980

01056271

08161800

08276500

dinamite

Installation

Appliance dimensions

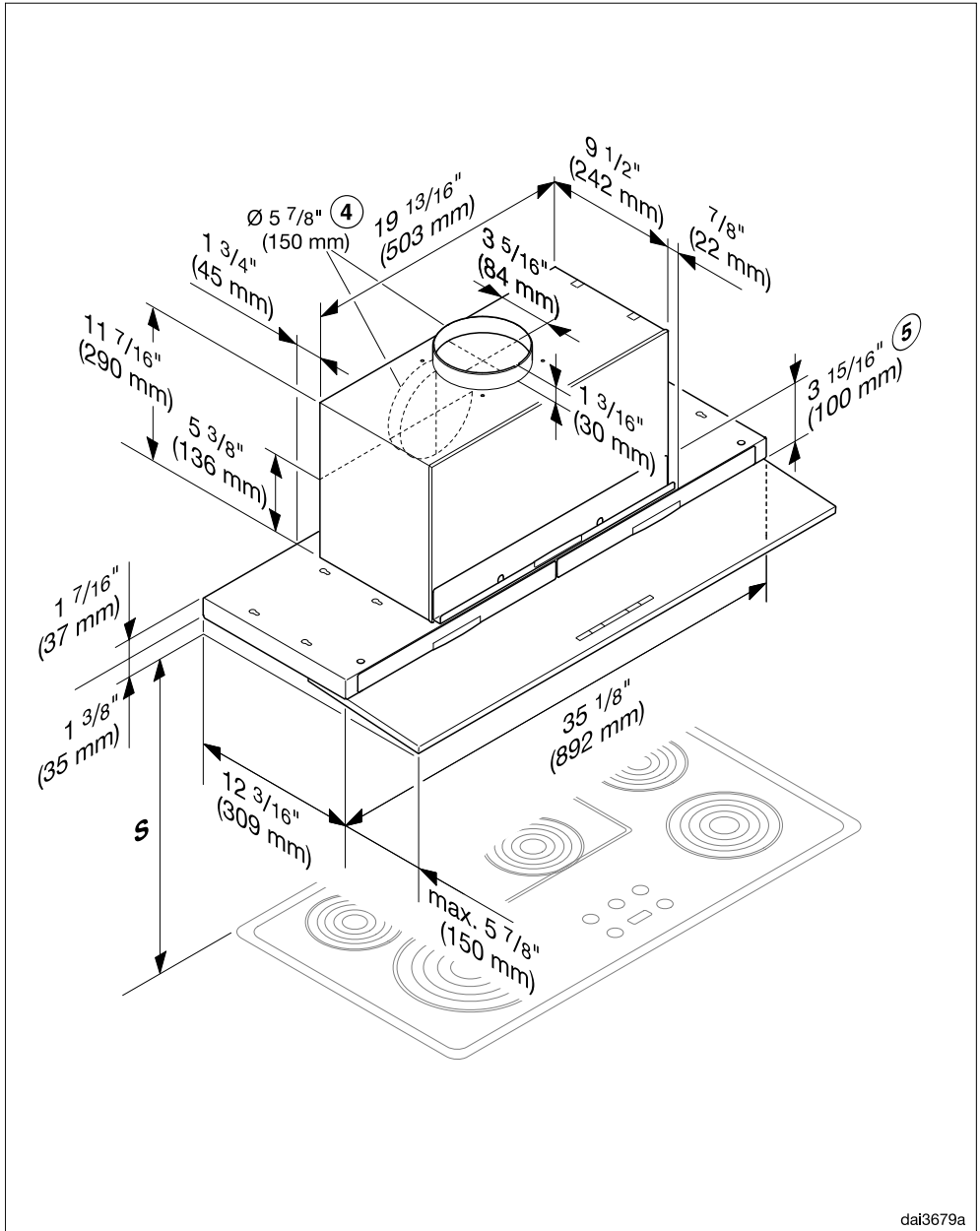

dai3679a

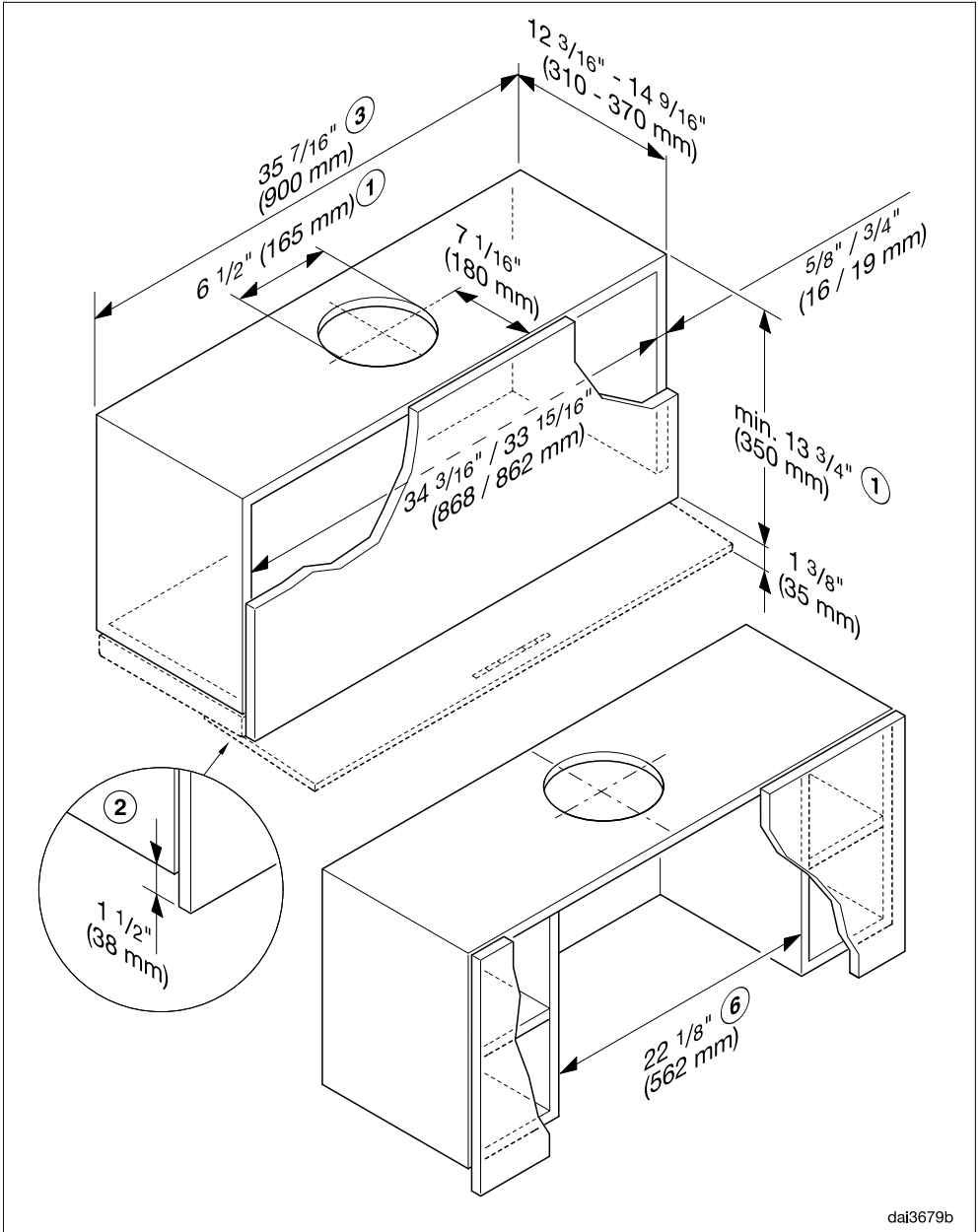

dai3679b

Installation

- ① Extraction, recirculation with conversion kit DUU 150.
- ② The wall unit housing needs to be 1 1/2" (38 mm) shorter than the wall unit door.
- ③ Installation is also possible in a 23 5/8" (600 mm) wide unit. In the process, the following must be observed:
 - The side units must also be shortened by 1 1/2" (38 mm).
 - The doors of the built-in unit and side units must be opened to the top so that the grease filters are accessible.
- ④ The ducting can also be connected at the back.
- ⑤ After installation, the wall unit can be fitted with an interim panel. If this is done, make sure that the slots for the grease filters and, for the charcoal filters in recirculation mode, remain easily accessible.
- ⑥ Alternatively, the wall unit can be fitted with side sections.

Distance between cooktop and ventilation hood (S)

Provided a larger distance is not given by the manufacturer of the cooktop, follow the minimum safety distances between a cooktop and the bottom of the hood.

Please also observe the information contained in the "IMPORTANT SAFETY INSTRUCTIONS" section.

Cooking appliance	Minimum distance S	
	Miele appliance	Non-Miele appliance
Electric Cooktops	24" (610 mm)	
Electric Barbeques and Fryers	26" (660 mm)	
Multiburner Gas Cooktops ≤ 43,000 BTU/hr (12.6 kW), no burner > 15,000 BTU/hr (4.5 kW).	26" (660 mm)	30" (760 mm)
Multiburner Gas Cooktops ≤ 73,800 BTU/hr (21.6 kW), no burner > 16,500 BTU/hr (4.8 kW)	30" (760 mm)	
Multiburner Gas Cooktops > 73,800 BTU/hr (21.6 kW), or one of the burners > 16,500 BTU/hr (4.8 kW)	Not possible	
Single Burner Gas Cooktops ≤ 20,500 BTU/hr (6 kW)	26" (660 mm)	30" (760 mm)
Single Burner Gas Cooktops > 20,500 BTU/hr (6 kW) ≤ 27,600 BTU/hr (8.1 kW)	30" (760 mm)	
Single Burner Gas Cooktops > 27,600 BTU/hr (8.1 kW)	Not possible	

Installation

Installation recommendations

- To achieve optimal vapor extraction, make sure that the hood covers the cooktop. The hood should be positioned centrally over the cooktop, not to the side or rear.
- The cooktop should be no wider than the hood. Preferably, it should be narrower for better extraction.
- The mounting area must be easily accessible. The ventilation hood should be easy to reach and disassemble in case a service call is necessary. This should be taken into consideration when planning the position of cabinetry, shelves, ceilings or decorative elements in the vicinity of the ventilation hood.

Before installation

 Before installing the appliance, read all of the information contained in this chapter and also in the "IMPORTANT SAFETY INSTRUCTIONS" section.

Repositioning the ducting

The blower can be rotated to allow the ducting to be fitted at the back of the hood. This may be necessary if the hood is being fitted in a reduced height wall unit, for example. Repositioning is carried out before installing the hood.

The ventilation hood must be disconnected from the power supply.

- Undo the fixing screws on the front panel of the ventilation hood housing and remove the panel.
- Undo the screws from the cover on the back of the ventilation hood housing and remove the cover.
- Unscrew the fixing screws on the motor unit.
- Turn the fan towards the rear and position the exhaust socket in the cut-out in the back panel of the ventilation hood housing. Ensure when turning the fan that the power cord does not become detached.
- Secure the fan in its new position.
- Now secure the cover taken from the back panel to the top of the housing.
- Refit the front panel and secure it using the screws.

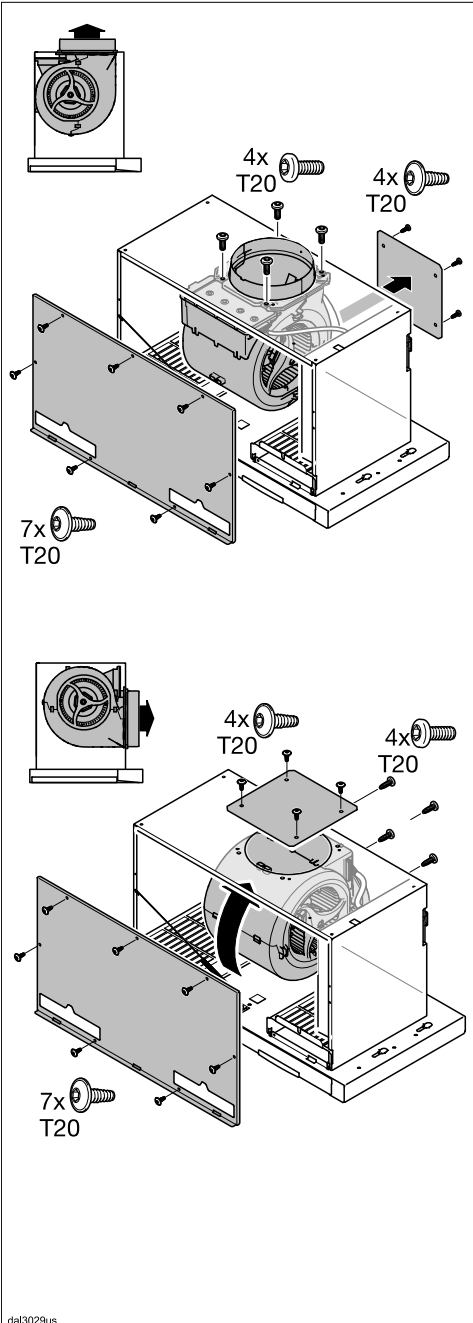

Installation

Installation Instructions

Please refer to the accompanying installation sheet for instructions on how to install the appliance.

Leave these instructions with the appliance for the consumer/user.

Information is subject to change. Please refer to our website to obtain the most current product specification, technical & warranty information.

WARNING: TO REDUCE THE RISK OF FIRE, ELECTRIC SHOCK, OR INJURY TO PERSONS, OBSERVE THE FOLLOWING:

All electrical work should be performed by a qualified electrician in strict accordance with national regulations (for USA: ANSI-NFPA 70) and local safety regulations.

Installation, repairs and other work by unqualified persons could be dangerous.

Ensure that power to the appliance is OFF while installation or repair work is performed.

Verify that the voltage, load and circuit rating information found on the data plate (located behind the baffle filters), match the household electrical supply before installing the hood.

Use only with ventilation hood cord-connection kits that have been investigated and found acceptable for use with this model hood.

If there is any question concerning the electrical connection of this appliance to your power supply, please consult a licensed electrician or call Miele's Technical Service Department.

WARNING: THIS APPLIANCE MUST BE GROUNDED

Grounding Instructions

WARNING - Improper grounding can result in a risk of electric shock.

This appliance must be grounded. In the event of an electrical short circuit, grounding reduces the risk of electric shock by providing a path of least resistance. This appliance is equipped with a cord having a grounding wire with a grounding plug.

If there is any doubt, have the electrical system of the house checked by a qualified electrician.

Do not use an extension cord. If the power supply cord is too short, have a qualified electrician install an outlet near the appliance.

- The plug must be plugged into an outlet that is properly installed and grounded.

WARNING - Grounding instructions (Canada)

The grounding-type attachment plug shall be connected to a grounding-type receptacle installed in accordance with CSA C22.1-12, Canadian Electrical Code, Part I.

Air venting

WARNING: Danger of toxic fumes. Gas cooking appliances release carbon monoxide that can be harmful or fatal if inhaled.

To reduce the risk of fire and to properly exhaust air, the exhaust gases extracted by the hood should be vented outside of the building only.

Do not vent exhaust air into spaces within walls or ceilings or in attics, crawl spaces or garages.

To reduce the risk of fire, only use metal ductwork.

Please read and follow the "IMPORTANT SAFETY INSTRUCTIONS" to reduce the risk of personal injury. Follow all local building codes when installing the hood.

Only use smooth pipes or flexible duct hoses made from non-combustible materials for exhaust ductwork.

To achieve the greatest possible air extraction with the lowest noise levels, please note the following:

- The diameter of the exhaust duct should not be less than 6" (150 mm).
- If flat exhaust ducts are used, the cross section should not be smaller than that of the exhaust connector.
- The exhaust duct should be as short and straight as possible.
- If elbows are needed, make sure they have a large radius.
- The exhaust duct itself must not be kinked or compressed.

- Make sure that all connections are secure and airtight.

Remember that any constriction of the airflow will reduce extraction performance and increase operating noise.

- If the exhaust duct is to be routed through an outside wall, we recommend installing a telescopic wall vent or a rooftop vent (available as an optional accessory).

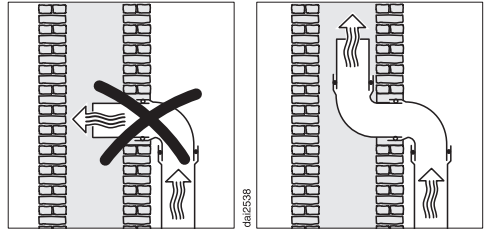

- If the exhaust air is conveyed into an exhaust air chimney, the inlet connector must face the flow direction.
- When installing the exhaust duct horizontally, a minimum slope of 1/8 inch per foot must be maintained to prevent condensate from flowing into the ventilation hood.
- If the exhaust duct is to be routed through cool rooms, ceilings, etc., the temperatures in these different areas may differ greatly. Therefore water condensation must be considered and the exhaust duct will need to be insulated.

Condensate trap

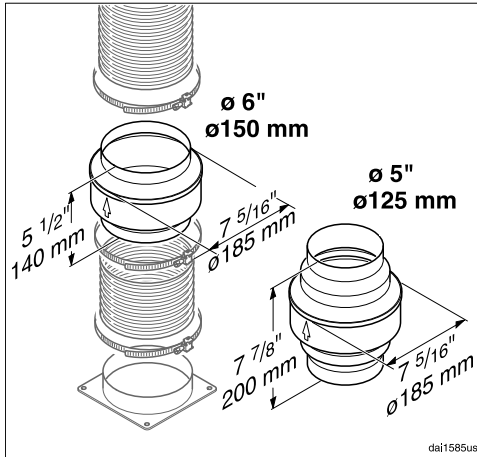

In addition to insulating the exhaust duct, we recommend installing a condensate trap to collect and evaporate any condensate which might accumulate.

Condensate traps are available for exhaust ducts with a diameter of 5" (125 mm) or 6" (150 mm).

- When installing a condensate trap, make sure that it is positioned vertically and, if possible, directly above the hood outlet duct collar. The arrow on the housing indicates the direction of airflow.

Reducing Collar

(optional accessory)

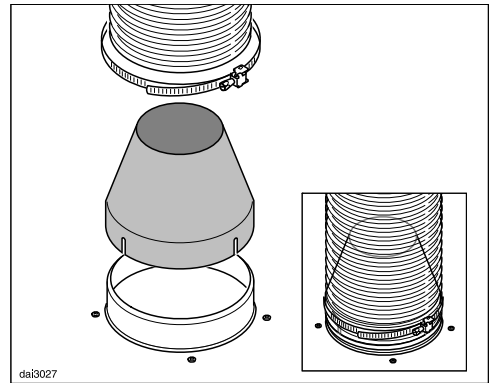

If you would like to reduce the environmental impact of your ventilation system by limiting the CFM output the Reducing Collar can be installed. It reduces the air flow to less than 400 CFM. Check local building codes for max. CFM requirements.

- Push the Reducing Collar on the exhaust port of the blower.
- Push the exhaust hose over it.
- Secure both with a hose clamp.

Activating Con@ctivity 2.0

Installation of the Con@ctivity 2.0 stick

In order for you to be able to use the Con@ctivity 2.0 function, the cooktop must be equipped with a Con@ctivity 2.0 stick.

- See the relevant installation instructions of the Con@ctivity 2.0 stick.

Activating the Con@ctivity 2.0 function

To use the Con@ctivity 2.0 function, the radio link between the cooktop and the ventilation hood must be activated.

Both appliances must be installed and operational.

Wireless connection must be activated on the ventilation hood and the cooktop at the same time. Activation on the ventilation hood is described below. Activation on the cooktop is described in the relevant operating and installation instructions. Please refer to the operating instructions before starting. Activate the ventilation hood first, then the cooktop.

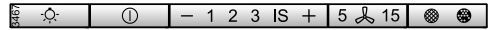
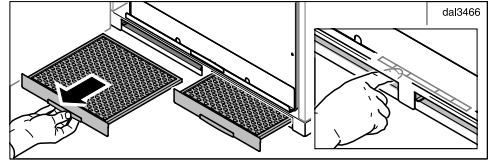

Activating the ventilation hood

Signing on/off is carried out with the canopy retracted.



- Remove the grease filters.

The controls are accessible via the slots for the grease filters.

- The cooktop and ventilation hood must be turned off.
- Press and hold the delayed shut down button **5**  **15** for approx. 10 seconds until the **1** indicator appears in the fan level display.
- Then, press the following buttons in order:
 - The **–** button
 - Followed by the **+** button
 - And then the lighting button .

If the remote control is already activated, **2** and **3** will light up constantly. If there is no wireless connection **2** and **3** will flash at the same time.

- To activate Con@ctivity 2.0, press the "+" button.

The search for a wireless connection will start.

- As this is happening, activate the cooktop.

Activating the cooktop

- **While** the ventilation hood is searching for a wireless connection, start activation on the cooktop. More information can be found in the operating instructions for the cooktop.
- When the cooktop registers that connection has been established, confirm activation on the ventilation hood with the delayed shut-down button **5**  **15**. All indicators will go out.
- Confirm activation on the cooktop.

The Con@ctivity 2.0 function is now ready for use.

If you do not confirm within 4 minutes, activation will be canceled.

You only need to carry out the activation procedure once. If the appliances are disconnected from the electricity supply, for example during a loss of power, they will still remain activated.

Activation failed

- If a wireless connection cannot be established despite activation of the Con@ctivity function on the ventilation hood and cooktop, the function must first be deactivated and then reactivated on both appliances.

Deactivating Con@ctivity 2.0

- Deactivation on the ventilation hood is carried out in the same way as activation, by selecting — instead of +.
- To deactivate the burner, please refer to the corresponding operating instructions.

Please keep in mind that disabling the connection will also disable any remote control function being used. The remote control must then be reactivated.

Signing the remote control on/off

If the connection has been lost between the remote control and the ventilation hood, the remote control and the remote control function on the ventilation hood must be signed on again. To do this, the remote control function on the ventilation hood and the remote control must first be signed off.

Signing on/off is carried out with the canopy retracted.

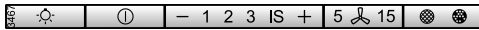
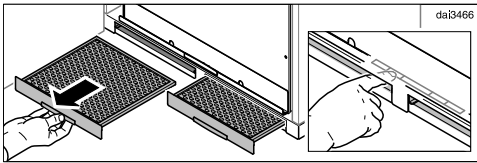



- Remove the grease filters.

The controls are accessible via the slots for the grease filters.

Signing on and off must be done at the same time on the ventilation hood and the remote control. Signing on/off mode has to be accessed on the ventilation hood first, then on the remote control.

Accessing signing on/off mode on the ventilation hood

- Press the delayed shut down button **5**  **15** for approx. 10 seconds until the **1** indicator appears in the fan level display.
- Then, press the following buttons in order:
 - The — button
 - Followed by the + button
 - And then the lighting button .
- Then access the signing on/off mode on the remote control immediately.

Accessing signing on/off mode on the remote control

- Press both arrow controls ∇/\wedge at the same time and hold for about 5 seconds until the remote control LED flashes.
- Press the lighting control .

Signing off

- In signing on/off mode press the "—" control on the ventilation hood and then on the remote control.

The remote control LED flashes steadily.

After approx. 10 seconds the remote control LED will flash on and off twice with a longer interval between the

Signing the remote control on/off

flashes. The remote control has now been signed off. The LED will go out after a short while.

- Confirm the signing off procedure by pressing the delayed shut down function control **5**  **15** on the ventilation hood. All indicators will go out.

Please bear in mind that disabling the signal will also disable any Con@ctivity 2.0 function and this will have to be activated again.

option control **5**  **15** on the ventilation hood and on the remote control.

- The signing on procedure must then be repeated. To do this, the ventilation hood and the remote control must first be signed off.

Starting the signing on procedure

- In signing on/off mode press the "+" control on the ventilation hood **first** and then on the remote control.

The search for a signal will commence. The remote control LED will flash steadily.

After approx. 30 seconds the remote control LED will flash on and off 4 times at short intervals. The connection has been established. The LED will go out after a short while.

- Confirm signing on with the ventilation hood delayed shut down function control **5**  **15**. All indicator lights will go out.

The remote control can now be used.

If you do not confirm within 4 minutes, activation will be canceled.

Canceling the signing on procedure

- If it is not possible to sign on, the procedure can be canceled by pressing the delayed shut down

Technical data

Fan motor	350 W
Overhead cooktop LED lighting	3 x 4.5 W
Total connected load	363.5 W
Voltage, frequency	120 V AC, 60 Hz
Fuse rating	15 A
Power cord length	2.5 ft (0.75 m)
Weight	41.8 lbs (19 kg)

Special accessories for recirculation mode:
Conversion kit DUU 150 or DUU 151 and Miele charcoal filter set DKF 19.
Contains two charcoal filters.



Contains
FCC ID: 2ACUWEI8800
IC: 5669C-EI8800

This device complies with Part 15 of the FCC Rules and with Industry Canada licence-exempt RSS standard(s). Operation is subject to the following two conditions: (1) this device may not cause harmful interference, and (2) this device must accept any interference received, including interference that may cause undesired operation.

da12491

**Please have the model and serial number
of your appliance available when
contacting Technical Service.**

The Miele logo consists of the word "Miele" in a bold, white, serif font, set against a solid black rectangular background.

U.S.A.

Miele, Inc.

National Headquarters

9 Independence Way
Princeton, NJ 08540
Phone: 800-843-7231
Fax: 609-419-4298
www.mieleusa.com

Technical Service & Support

Phone: 800-999-1360
Fax: 888-586-8056
TechnicalService@mieleusa.com

International Headquarters

Miele & Cie. KG
Carl-Miele-Straße 29
33332 Gütersloh
Germany

Canada

**Importer
Miele Limited**

Headquarters and Miele Centre

161 Four Valley Drive
Vaughan, ON L4K 4V8
www.miele.ca

Customer Care Centre

Phone: 800-565-6435
905-532-2272
customercare@miele.ca

DA 3690



en-US

M.-Nr. 10 625 750 / 00